



Tel : 450-967-5555

Fax : 450-967-5338

Panel Parts			
A	Control Panel Lid	30147451	265.00
B	Lid Pin with Handle	30147352	8.35
C	Lid Pin	30147351	5.75
	Roll Pin	31146645	3.35
D	Rubber Bumber	30145645	1.45
E	Lid Lifter	30145601	22.50
E	Lid Lifter	30145602	22.50
F	Quick Disc Female	30171701	16.35
	Quick Disc Male <u>W/Cut</u> Shut Off V	30171702	11.85
G	Quick Disc Male <u>With</u> Shut Off V	30171703	16.35
H	Outlet conv.	30161772	4.96

FLOW TRAY PARTS			
I	Saliva Tip Assembly	38283000	32.90
J	Hi Volume Tip Assembly	38282000	38.95
K	Clip Metal Instr. Cox	38147132	4.20
L	Instrument Hanger Saliva	38383402	5.10
M	Instrument Hang. Hi. Volume	38383404	5.10
	Adjustable Leveller Leg	25133899	2.84
	Square Plastic Insert	25137799	2.86
P	On/Of Switch Cox Tray	38383405	62.50
Q	Frame Insert	25116699	1.86
R	Flow Tray (Black)	38383401	83.35
S	Flow Arms Assembly	38182000	126.32
T	Flow Post	38181321	38.50
U	Flow Counter Bushing	38146401	20.25
V	Flow Sheath Assembly	38181000	182.35
W	Flow Mounting Clip	38181403	8.32

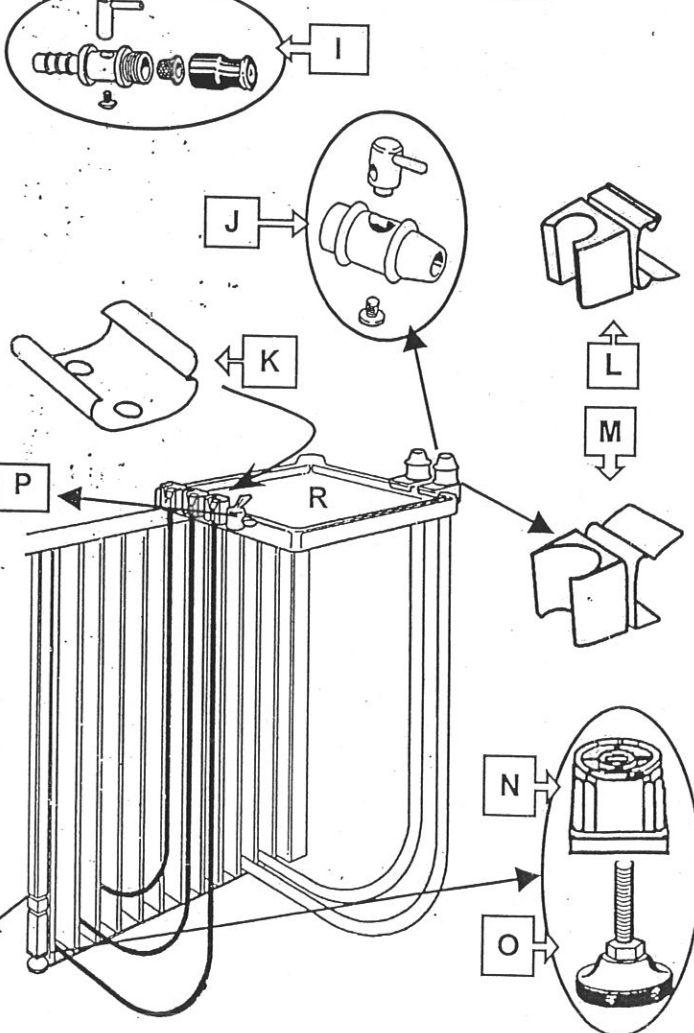
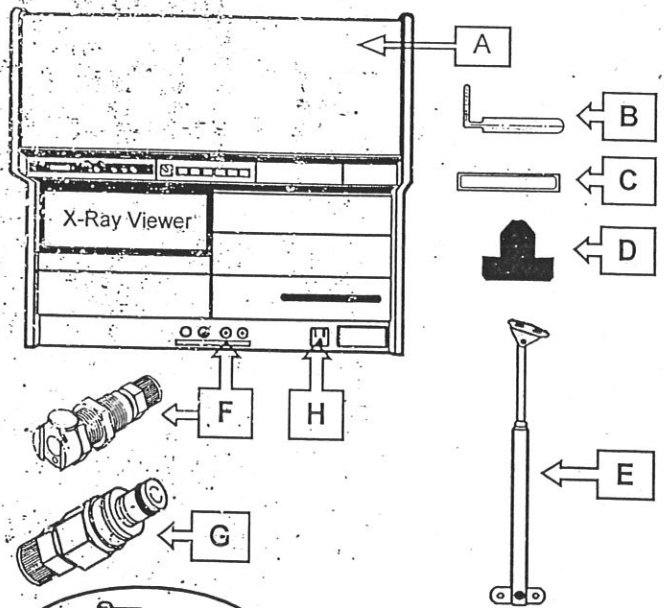



Tel : 450-967-5555

Fax : 450-967-5338

Vac Manifold assembly		\$
	VHP Manifold Complet	38281000 162.50
A	Manifold Retainer	31145315 12.65
BtoF	Manifold Bloc & Attachement	38281316 121.00
C	Connector Male 5/16X1/8	38281546 3.75
	VHP Brass Plug	38281344 2.50
D	Nipple 1" Vacuum Hose	38281343 14.16
E	Nipple 5/8" Hi Vol Handpiece	38281342 11.16
F	Connector 90° Brass	38281545 3.55
G	Gasket (VHP)	38247626 1.95
H	Tube <u>Push</u> Fit (VHP)	38281340 16.85
H	Tube <u>Screw</u> Fit (VHP)	38281341 19.50
I	Filter (VHP)	38281436 5.45
J	Plastic Jar (VHP)	38247625 3.30
	JAR Adapter	38247624 8.65
K	HI VOLUME TIP ASSEMBLY	38282000 38.95
SALIVA EJECTOR TIP ASSBLY.		\$
L	Saliva Tip Assembly	38283000 32.90
	Saliva Screen	38283629 4.38
N	Black Rubber Saliva tip	38283627 6.85
O	Saliva Eject. Tube 3/16"	38283515 9.50
	Saliva Eject. Ring Tip	38283628 3.05
P	Hosing 5/8"ID Gray Ribbed	38282514 14.10
Q	Drain Hose 1" White Ribbed	38281513 9.00
	T-Bar Length 16"	31145601 7.50
R	Instrument Hanger Saliva	38383402 5.10
S	Instrument Hanger Hi Volume	38383404 5.10
PLUMBING PARTS		
T	Faucet Assembly	31154000 168.00
U	Faucet Handle	31154706 38.45
V	Soap Dispenser Assembly	31155000 32.35
W	Soap Dispenser Bottle	31151708 4.15
X	Sink Assembly (Rectang)	31152000 59.95
Y	Drain Grid	31146717 6.00

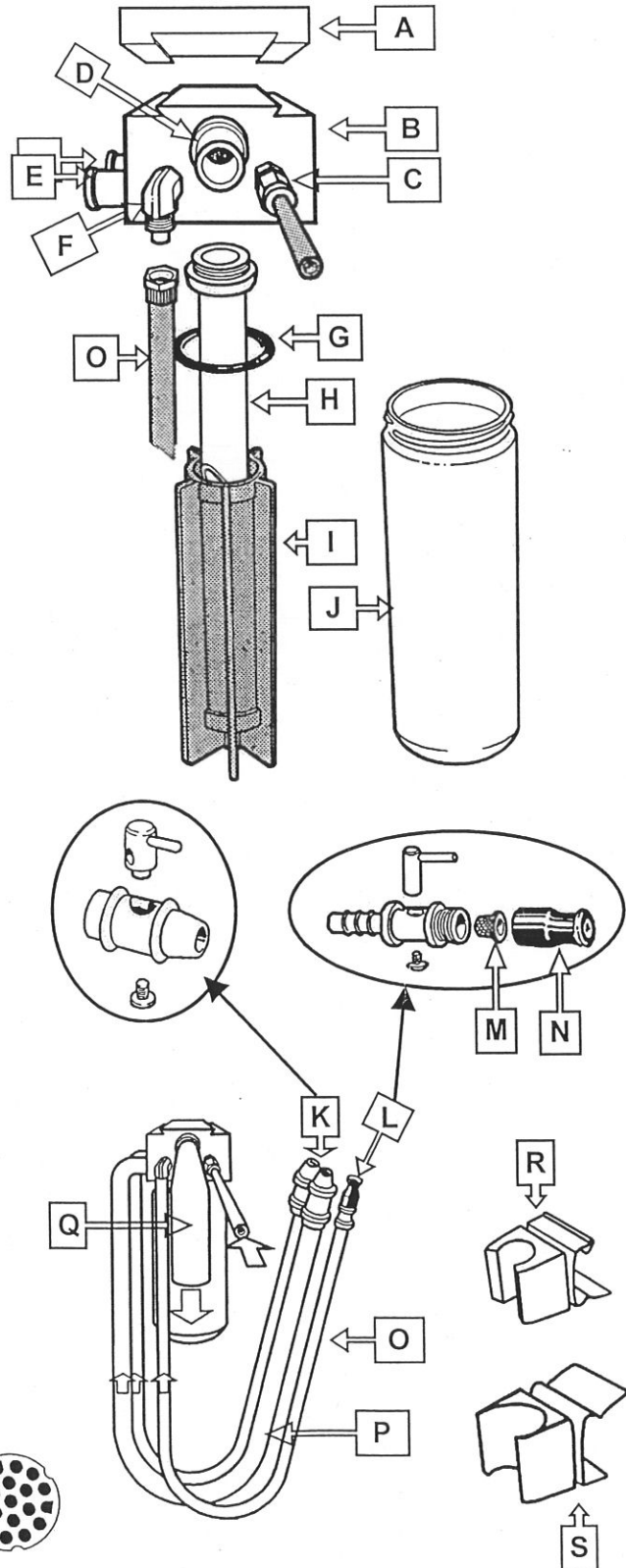

1661 de Lunebourg, laval, Qc, Canada, H7M 4J7



cox systems
MODUDENT INC.

Tel : 450-967-5555

Fax : 450-967-5338

Miscellaneous parts			\$
A	Sqare Plastic Insert	25137799	2,15
B	Adjustable Leveller Leg	25138899	1,60
	Shelf Clip	31246547	0.88
C	Lab Door Plastic Glide	32244612	1.54
D	Lab Door Roller (Sliding door)	32244613	4.75
	Lab Sld Door Track 70 1/4	32245209	27.09
	CSL Waste Basket	32647615	9.25
E	Block Hill	30171403	4.50
	Waste Hanger Sink	33145164	7.10
	Hinge Piano Sink	33145271	7,25
	Drawer Pulls Aluminium	33145301	5.35
	Dwr Pull Plastic	33145401	N/A
F	Friction Arm Right	33145542	6.65
F	Friction Arm Left	33145543	6.65
	Scott Towell Holder White	33145605	6.46
G	CSS Waste Basket	33147441	29.75
H	Tutch Latch Metal	33245609	4.00
	Instruments Hanger (Loover)	33347111	3.36
	AAM Strain Relief	33445610	2.96
I	AAM Caster Grey	33445616	19.85
J	Magnetic Catch	33545611	1,15
STORAGE PARTS			\$
K	Mini- Bins	30144426	5.40
L	AAM Step Tray	33447406	25.15
M	AAM 3 Part Bin	33447407	25.15
N	Tray Insert Flat	38484401	23,94
O	Tray Insert Divid	38484402	23,94
P	People Flow Chart Holder	311XN000	26.40
Q	Pilot Air Valve 125 (silver)	30172901	43.30
Q	Pilot Water Valve 125 (brass)	30172902	72.35
Switch Air Electrique			\$
R	Raccord Male	30161727	3.75
S	Oper Aior Pilot	30161726	14.75
T	Switch Air /Elect (Elact Side)	30161752	32.50

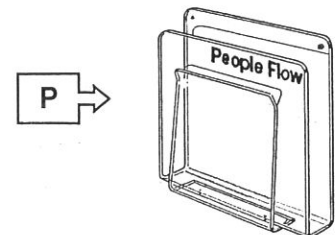
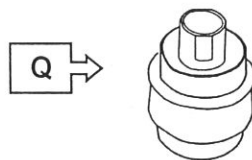
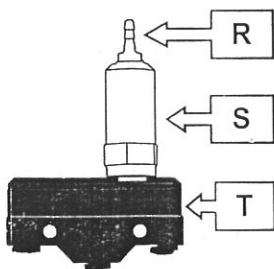
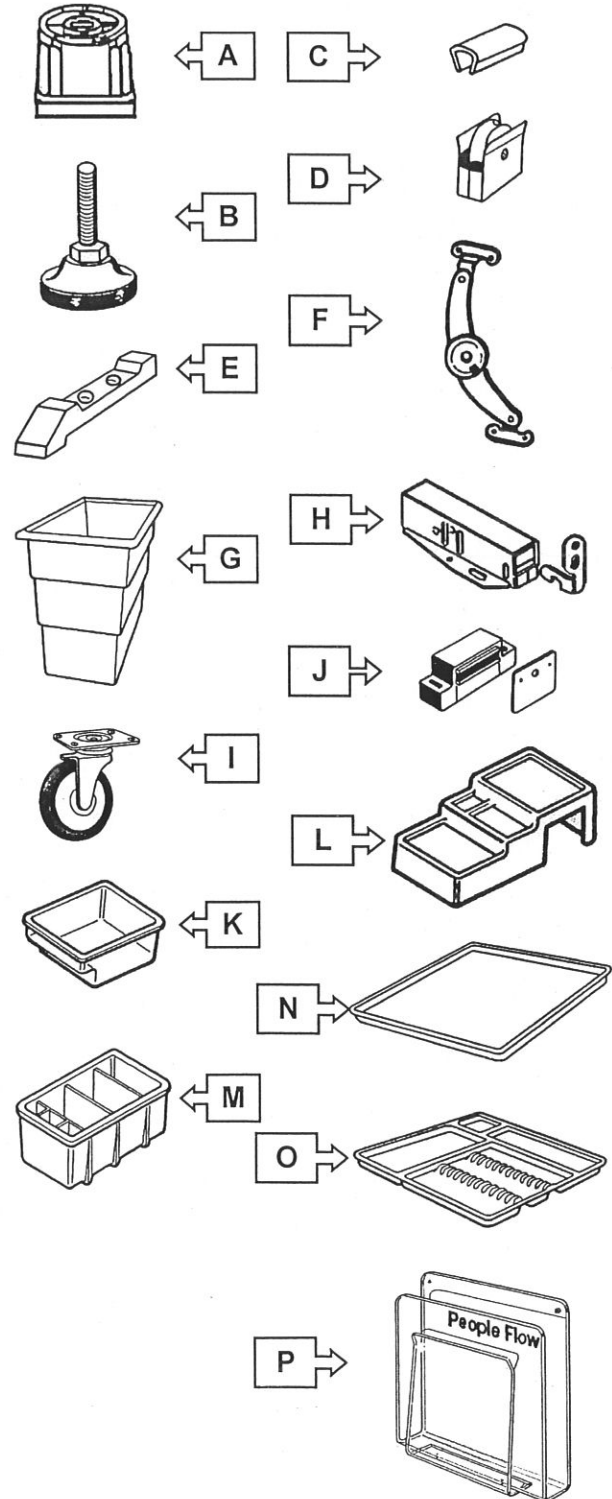

1661 de Lunenburg, Laval, Qc, Canada, H7M 4J7



ELECTRICAL PARTS		\$
Switch Modules	30161000	384.00
Plastic Bumper Switch mod	30161435	0.37
A Switch Main Air	30161725	35.75
B Red Cap Display Screen (switch)	30161541	6.52
C White Cap Display Screen (switch)	30161542	6.52
D Yellow Cap Display Screen (switch)	30161543	6.52
E Blue Cap Display Screen (switch)	30161544	6.52
F Green Cap Display Screen (switch)	30161545	6.52
G Spacer Micro Switch	38147388	5.62
H Body Micro Switch Compl	30161758	94.75
I Micro Bulb Cox 1(Metal)	38147387	3.80
Mini switch Lamp All Glass)	30161762	3.80
J Outlet conv.	30161772	4.96
K Red Paddle Switch	30161756	9.85
L Red Clair Rocker Switch	30161757	9.85
M Clair Rocker Switch	30161755	9.85
N White Rocker Switch	30161754	9.85
Breaker Circuit 10 amp (reset)	30161681	14.75
Transformer	30161691	26.48

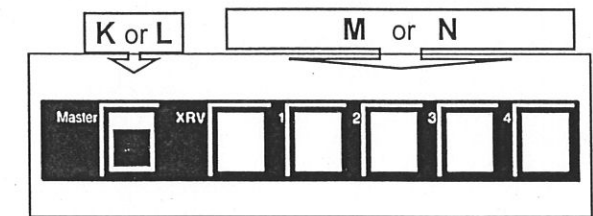
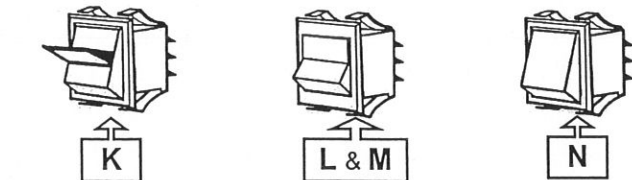
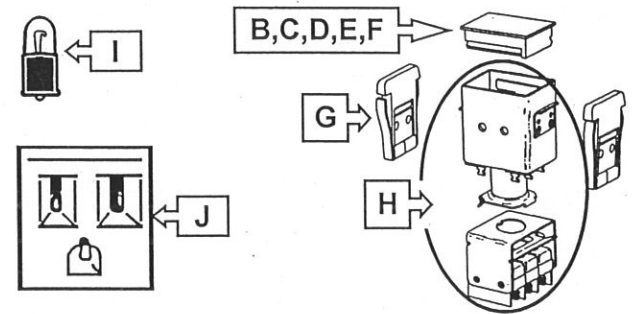
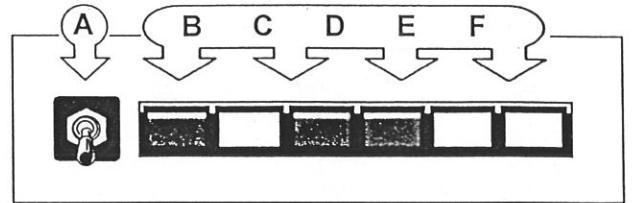

X-RAY VIEWER		\$
Ballast X-Ray single tube	30161692	28.50
Ballast X-Ray 2 tube (Gen1)	30161693	28.50
O X-Ray Lamp Holder	30162763	4.15
P X-Ray Gable Swivel	30162317	33.70
Q X-Ray Hinge Swivel	30162316	24.75
R X-Ray Mounting Slide (cast All)	30162381	32.00
S X-Ray Mounting Slide Female	30145381	6.5
T X-Ray Shim	30162320	2.35
X-Ray Acrilic Screen 5 1/2 X 15 3/4	30162465	14.55
X-Ray Screen Tble Mte 5 X 16 3/4	30162466	14.55
X-Ray Lamp Neon	30162764	11.50
U Lab Togle Switch	32261753	5.10
Lab Breaker Circuit 12amp	32261681	12.80

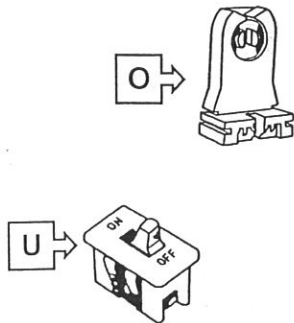
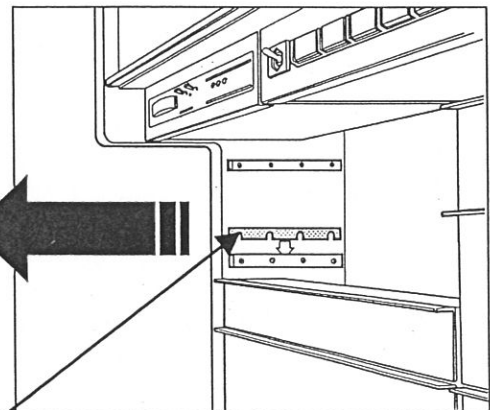

1661 de Lunenburg, Laval, Qc, Canada, H7M 4J7

MCRT Parts List (Retraction)

RT-DRM1

Dart clip

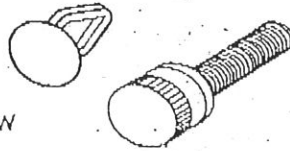

RT-THSCW2

Thumb Screw

RT-A22-055

Auto holder

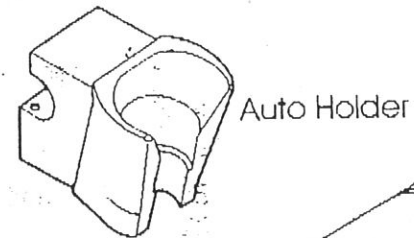

Auto Holder

RT-SHIELD

Shield, specify # of ports

RT-G16-1

Clippard cylinder (single)

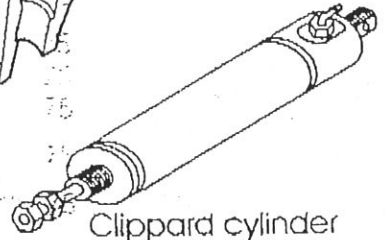

Clippard cylinder

RT-TOGGLE

1/4" x 1/4" loop assembly holders w/ socket cap screw

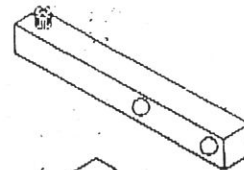

RT-TOGMT1

Nylon plastic mount for toggle assembly (single)

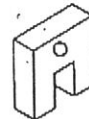

RT-TOGMT2

Nylon plastic mount for toggle assembly (double, high volume)

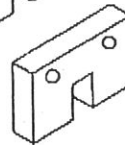

RT-WAND1

1/8" dia. fiberglass wand w/ loop (single)

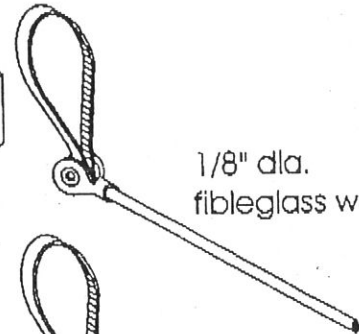

1/8" dia. fiberglass wand

RT-WAND2

5/32" dia. fiberglass wand w/ loop (double, high volume)

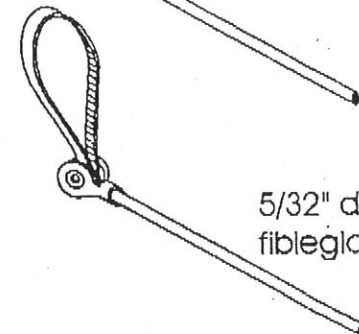

5/32" dia. fiberglass wand

RT-MEB1N

Poly elbow 10/32 Port



RT-4-40316

Socket cap screw



RT-1858-DOWP

1/8" x 5/8" metal dowel pin (single)

RT-181-DOWP

1/8" x 1" metal dowel pin (double, high volume)

RT-C88

1/2" x 1/2" nylon barbed hose mender (high volume)

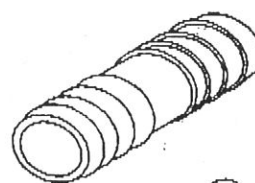

RT-17-781

Spirel flex tubing (high volume)

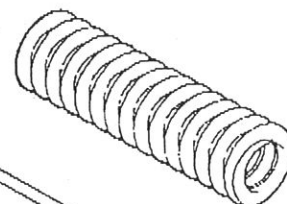

RT-CLPDV

Clippard divider, nylon

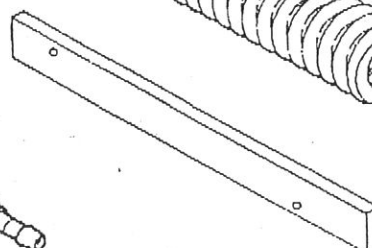

RT-DRLRD

1/8" steel drill rod

RT-0016-275

1/16" barbed "y" (double cylinder air line)

